

# IP4264CZ8-20; IP4264CZ8-40

Integrated USIM/SIM card passive filter arrays with ESD protection

Rev. 3 — 22 July 2010

Product data sheet

## 1. Product profile

### 1.1 General description

The IP4264CZ8-20 and IP4264CZ8-40 are 3-channel RC low-pass filter arrays which are designed to provide filtering of undesired RF signals in the 800 MHz-to-6000 MHz frequency band. In addition, the IP4264CZ8-20 and IP4264CZ8-40 incorporate diodes to provide protection to downstream components from ElectroStatic Discharge (ESD) voltages up to  $\pm 25$  kV contact and higher than  $\pm 25$  kV air discharge far exceeding IEC 61000-4-2, level 4.

Both IP4264CZ8-20 and IP4264CZ8-40 support ESD protection of the USB data pins of an Universal Subscriber Identity Module (USIM) interface as well as the digital standard SIM interface ESD protection and ElectroMagnetic Interface (EMI) filtering.

The IP4264CZ8-20 and IP4264CZ8-40 are fabricated using monolithic silicon technology. They integrate three resistors and seven high-level ESD protection diodes in a 0.4 mm pitch 8-pin Micropak (compatible with Quad Flat-pack No-leads (QFN)) lead-free plastic package with a height of only 0.5 mm.

These features make the IP4264CZ8-20 and IP4264CZ8-40 ideal for use in applications requiring component miniaturization such as mobile phone handsets, cordless telephones and personal digital devices.

The devices are also available in Wafer Level Chip-Size Package (WLCSP): WLCSP11 (for USIM) with 0.4 mm pitch (IP4365CX11), and WLCSP8 (for SIM) with both 0.4 mm pitch (IP4364CX8/LF) and 0.5 mm pitch (IP4064CX8/LF).

### 1.2 Features and benefits

- Pb-free, Restriction of Hazardous Substances (RoHS) compliant and free of halogen and antimony (Dark Green compliant)
- 3-channel SIM card interface with integrated RC-filter array and SIM voltage ESD protection
- 2 USIM (USB1.1) compliant ESD protection diodes with 20 pF channel capacitance
- Integrated 100  $\Omega$ /100  $\Omega$ /47  $\Omega$  series channel resistors
- Total channel capacitance of 20 pF (IP4264CZ8-20) or 40 pF (IP4264CZ8-40)
- Downstream ESD protection up to  $\pm 25$  kV (contact) according to IEC 61000-4-2
- Micropak (QFN compatible) plastic package with 0.4 mm pitch
- Also available in WLCSP11: IP4365CX11 (USIM interface) and in WLCSP8: IP4364CX8/LF (0.4 mm pitch) and IP4064CX8/LF or IP4044CX8/LF (both using 0.5 mm pitch, SIM interface)



## 1.3 Applications

- USIM and SIM interfaces in e.g. cellular and Personal Communication System (PCS) mobile handsets

## 2. Pinning information

Table 1. Pinning

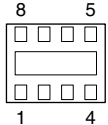
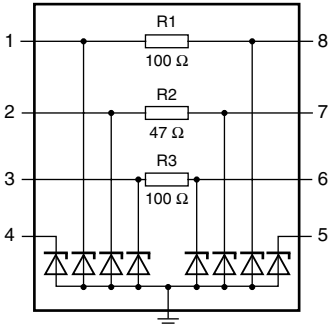
Pin	Description	Simplified outline	Graphic symbol
1 and 8	filter channel 1	 <p>Transparent top view</p>	
2 and 7	filter channel 2		
3 and 6	filter channel 3		
4 and 5	ESD protection		
GND	ground		

018aaa015

## 3. Ordering information

Table 2. Ordering information

Type number	Package		Version
	Name	Description	
IP4264CZ8-20	HXSON8U	plastic thermal enhanced extremely thin small outline package; no leads; 8 terminals; UTLP based; body 1.35 × 1.7 × 0.5 mm	SOT983-1
IP4264CZ8-40			

## 4. Marking

Table 3. Marking codes

Type number	Marking code
IP4264CZ8-20	N2
IP4264CZ8-40	N4

## 5. Limiting values

**Table 4. Limiting values**

*In accordance with the Absolute Maximum Rating System (IEC 60134).*

Symbol	Parameter	Conditions	Min	Max	Unit
$V_I$	input voltage	at I/O pins	-0.5	+5.5	V
$V_{ESD}$	electrostatic discharge voltage	all pins to ground			
		IP4264CZ8-20	contact discharge	[1] -	±15
		air discharge	[1] -	±15	kV
	IP4264CZ8-40	contact discharge	[2] -	±25	kV
		air discharge	[2] -	±25	kV
		IEC 61000-4-2, level 4; all pins to ground			
		contact discharge	-	±8	kV
	air discharge	-	±15	kV	
$P_{ch}$	channel power dissipation	$T_{amb} = 70\text{ °C}$	-	60	mW
$P_{tot}$	total power dissipation	$T_{amb} = 70\text{ °C}$	-	180	mW
$T_{stg}$	storage temperature		-55	+150	°C
$T_{reflow(peak)}$	peak reflow temperature	$t_p \leq 10\text{ s}$	-	260	°C
$T_{amb}$	ambient temperature		-35	+85	°C

[1] IP4264CZ8-20 is qualified to 1000 contact discharges of ±15 kV using the IEC 61000-4-2 model far exceeding the specified IEC 61000-4-2, level 4 (8 kV contact discharge).

[2] IP4264CZ8-40 is qualified to 1000 contact discharges of ±25 kV using the IEC 61000-4-2 model far exceeding the specified IEC 61000-4-2, level 4 (8 kV contact discharge).

## 6. Characteristics

**Table 5. Channel resistance**

$T_{amb} = 25\text{ }^{\circ}\text{C}$  unless otherwise specified.

Symbol	Parameter	Conditions	Min	Typ	Max	Unit
$R_{s(ch)}$	channel series resistance	R1, R3	75	100	125	$\Omega$
		R2	35.2	47	58.8	$\Omega$

**Table 6. Channel characteristics**

$T_{amb} = 25\text{ }^{\circ}\text{C}$  unless otherwise specified.

Symbol	Parameter	Conditions	Min	Typ	Max	Unit
<b>IP4264CZ8-20</b>						
$C_{ch}$	channel capacitance	$f = 1\text{ MHz}$	<a href="#">[1][2]</a>			
		$V_{bias(DC)} = 0\text{ V}$	-	17	20	pF
		$V_{bias(DC)} = 2.5\text{ V}$	-	11	15	pF
<b>IP4264CZ8-40</b>						
$C_{ch}$	channel capacitance	$f = 1\text{ MHz}$	<a href="#">[1][2]</a>			
		$V_{bias(DC)} = 0\text{ V}$	-	35	40	pF
		$V_{bias(DC)} = 2.5\text{ V}$	-	23	28	pF
<b>IP4264CZ8-20; IP4264CZ8-40</b>						
$C_d$	diode capacitance	$f = 1\text{ MHz}$	<a href="#">[3]</a>			
		$V_{bias(DC)} = 0\text{ V}$	12	16	20	pF
		$V_{bias(DC)} = 2.5\text{ V}$	8	11	14	pF
$I_{RM}$	reverse leakage current	$V_I = 3\text{ V}$	-	-	50	nA
$V_{BR}$	breakdown voltage	$I_{test} = 1\text{ mA}$	6	-	10	V

[1] Guaranteed by design.

[2] Total line capacitance including diode capacitance, per channel.

[3] Measured between pins 4 and 5.

7. Application information

7.1 Insertion loss

The IP4264CZ8-20 and IP4264CZ8-40 are mainly designed as EMI/Radio Frequency Interference (RFI) filters for SIM card interfaces. The setup for measuring the return loss is shown in [Figure 1](#).

The insertion loss in a 50 Ω system for all three channels of the IP4264CZ8-20 with a line capacitance of ≤ 20 pF total channel capacitance is shown in [Figure 2](#).

And the insertion loss for IP4264CZ8-40 with a line capacitance of ≤ 40 pF channel capacitance is shown in [Figure 3](#).

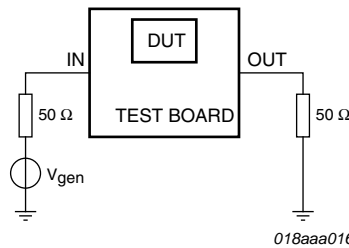
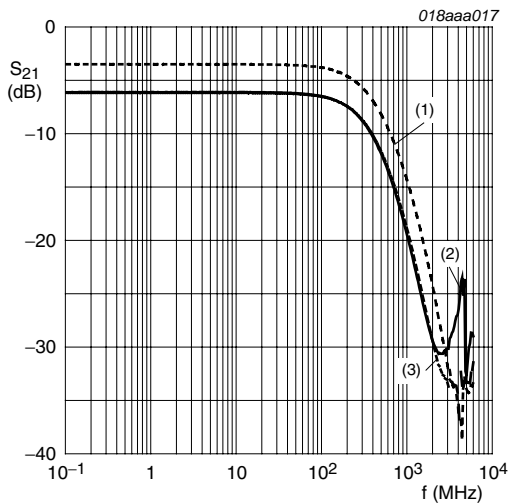
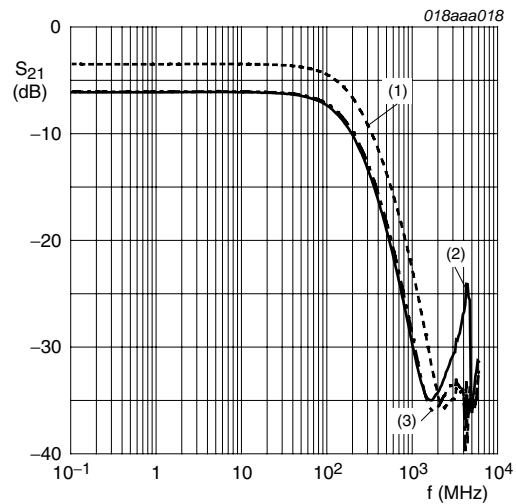

Fig 1. Frequency response setup



C<sub>ch</sub> = 20 pF  
 (1) Pin 2 to 7  
 (2) Pin 1 to 8  
 (3) Pin 3 to 6

Fig 2. Frequency response curves for IP4264CZ8-20



C<sub>ch</sub> = 40 pF  
 (1) Pin 2 to 7  
 (2) Pin 1 to 8  
 (3) Pin 3 to 6

Fig 3. Frequency response curves for IP4264CZ8-40

7.2 Crosstalk

The setup for measuring crosstalk between channels in a 50 Ω system is shown in Figure 4. The crosstalk for the IP4264CZ8-20 is shown in Figure 5 and Figure 6 for the IP4264CZ8-40. Unused channels are terminated with a 50 Ω resistor to ground.

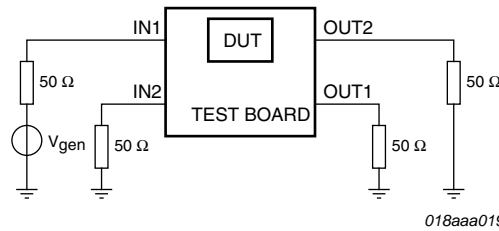
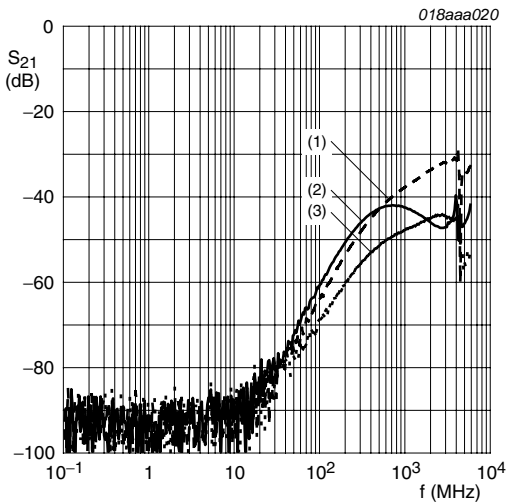
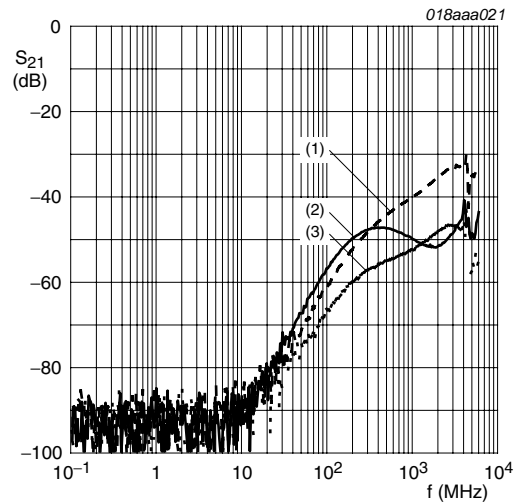

Fig 4. Crosstalk measurement setup



C<sub>ch</sub> = 20 pF  
 (1) Pin 1 to 7  
 (2) Pin 2 to 6  
 (3) Pin 3 to 8

Fig 5. Crosstalk behavior for IP4264CZ8-20



C<sub>ch</sub> = 40 pF  
 (1) Pin 1 to 7  
 (2) Pin 2 to 6  
 (3) Pin 3 to 8

Fig 6. Crosstalk behavior for IP4264CZ8-40

### 7.3 USIM interface application schematic

The application schematic diagram depicted in [Figure 7](#) demonstrates how the NXP SIM card EMI filter and ESD protection devices IP4264CZ8 are used in a typical USIM interface application.

For example, in case a standard SIM interface without USB1.1 is used, the two single diodes (pins 4 and 5) can protect the VSIM line.

Please note that this is only one example dependent on layout constraints e.g. channels 1 to 8 can be swapped with channels 3 to 6.

Also, the USB interface ESD protection pins 4 and 5 can be exchanged. Due to both sides of the devices containing identical protection diodes, baseband and SIM card side can be swapped, too (pin 1 with pin 8, pin 2 with pin 7 etc.).

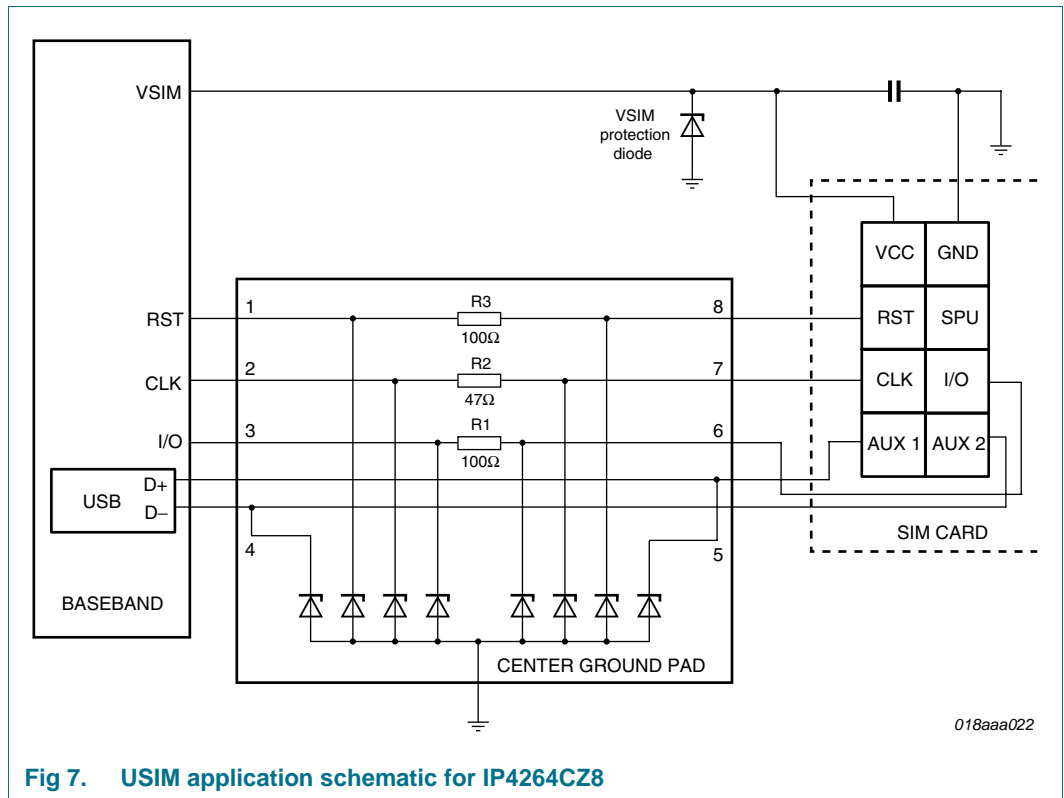

Fig 7. USIM application schematic for IP4264CZ8

## 8. Package outline

**HXSON8U:** plastic thermal enhanced extremely thin small outline package; no leads;  
8 terminals; UTLP based; body 1.35 x 1.7 x 0.5 mm

SOT983-1

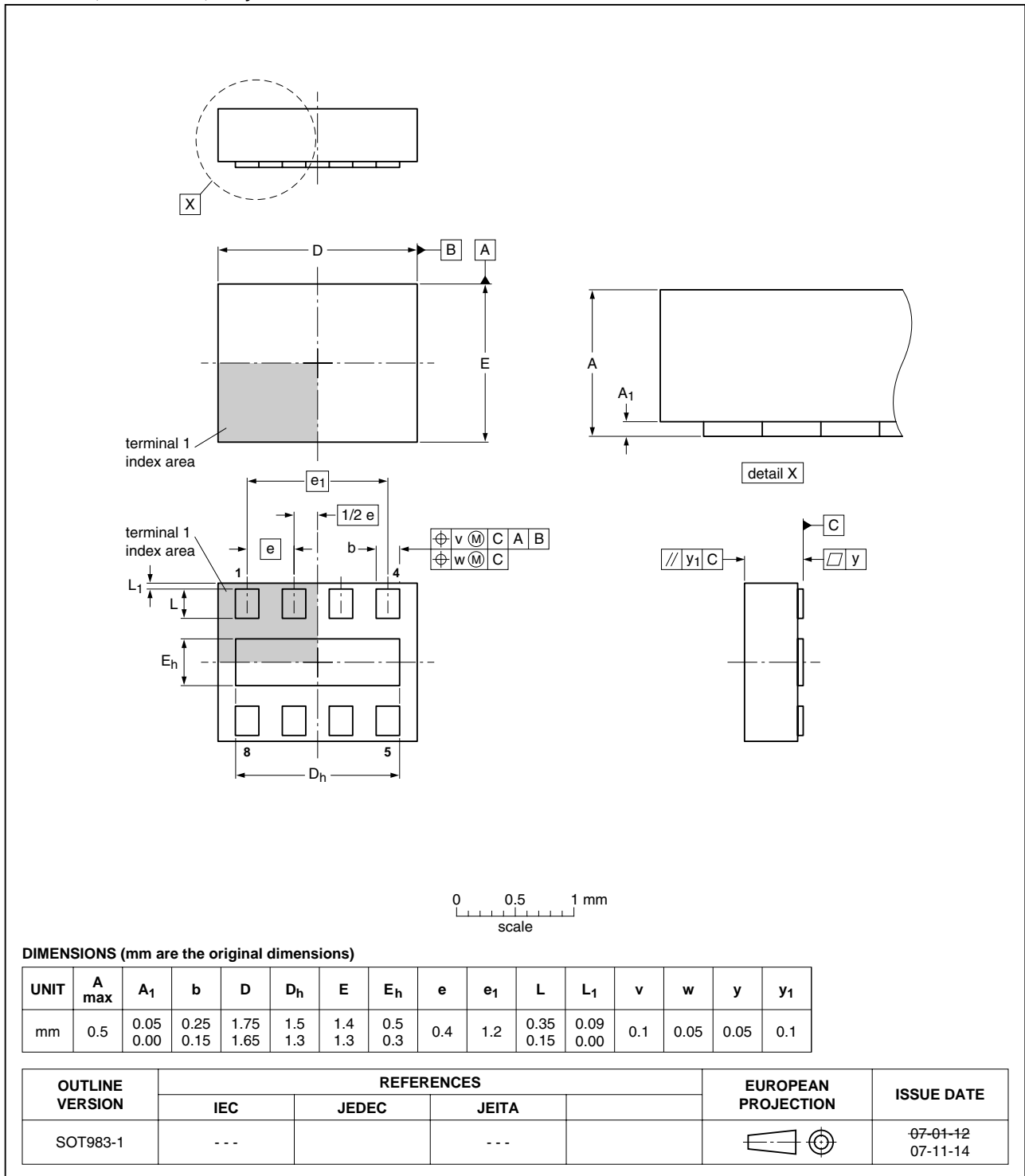

Fig 8. Package outline SOT983-1 (HXSON8U)



## 9. Revision history

Table 7. Revision history

Document ID	Release date	Data sheet status	Change notice	Supersedes
IP4264CZ8-20_ IP4264CZ8-40 v.3	20100722	Product data sheet	-	IP4264CZ8-20_ IP4264CZ8-40_2
Modifications:				
				<ul style="list-style-type: none"> <li>• <a href="#">Section 1 "Product profile"</a>: added USIM application</li> <li>• <a href="#">Table 1 "Pinning"</a>: corrected graphic symbol</li> <li>• <a href="#">Table 6 "Channel characteristics"</a>: added C<sub>d</sub> maximum and minimum values</li> <li>• <a href="#">Figure 1, 2, 3, 4, 5 and 6</a>: updated</li> <li>• <a href="#">Section 7.3 "USIM interface application schematic"</a>: added</li> <li>• <a href="#">Section 10 "Legal information"</a>: updated</li> </ul>
IP4264CZ8-20_ IP4264CZ8-40_2	20090427	Product data sheet	-	IP4264CZ8-20_ IP4264CZ8-40_1
IP4264CZ8-20_ IP4264CZ8-40_1	20081106	Objective data sheet	-	-

## 10. Legal information

### 10.1 Data sheet status

Document status <sup>[1][2]</sup>	Product status <sup>[3]</sup>	Definition
Objective [short] data sheet	Development	This document contains data from the objective specification for product development.
Preliminary [short] data sheet	Qualification	This document contains data from the preliminary specification.
Product [short] data sheet	Production	This document contains the product specification.

[1] Please consult the most recently issued document before initiating or completing a design.

[2] The term 'short data sheet' is explained in section "Definitions".

[3] The product status of device(s) described in this document may have changed since this document was published and may differ in case of multiple devices. The latest product status information is available on the Internet at URL <http://www.nxp.com>.

### 10.2 Definitions

**Draft** — The document is a draft version only. The content is still under internal review and subject to formal approval, which may result in modifications or additions. NXP Semiconductors does not give any representations or warranties as to the accuracy or completeness of information included herein and shall have no liability for the consequences of use of such information.

**Short data sheet** — A short data sheet is an extract from a full data sheet with the same product type number(s) and title. A short data sheet is intended for quick reference only and should not be relied upon to contain detailed and full information. For detailed and full information see the relevant full data sheet, which is available on request via the local NXP Semiconductors sales office. In case of any inconsistency or conflict with the short data sheet, the full data sheet shall prevail.

**Product specification** — The information and data provided in a Product data sheet shall define the specification of the product as agreed between NXP Semiconductors and its customer, unless NXP Semiconductors and customer have explicitly agreed otherwise in writing. In no event however, shall an agreement be valid in which the NXP Semiconductors product is deemed to offer functions and qualities beyond those described in the Product data sheet.

### 10.3 Disclaimers

**Limited warranty and liability** — Information in this document is believed to be accurate and reliable. However, NXP Semiconductors does not give any representations or warranties, expressed or implied, as to the accuracy or completeness of such information and shall have no liability for the consequences of use of such information.

In no event shall NXP Semiconductors be liable for any indirect, incidental, punitive, special or consequential damages (including - without limitation - lost profits, lost savings, business interruption, costs related to the removal or replacement of any products or rework charges) whether or not such damages are based on tort (including negligence), warranty, breach of contract or any other legal theory.

Notwithstanding any damages that customer might incur for any reason whatsoever, NXP Semiconductors' aggregate and cumulative liability towards customer for the products described herein shall be limited in accordance with the *Terms and conditions of commercial sale* of NXP Semiconductors.

**Right to make changes** — NXP Semiconductors reserves the right to make changes to information published in this document, including without limitation specifications and product descriptions, at any time and without notice. This document supersedes and replaces all information supplied prior to the publication hereof.

**Suitability for use** — NXP Semiconductors products are not designed, authorized or warranted to be suitable for use in life support, life-critical or safety-critical systems or equipment, nor in applications where failure or

malfunction of an NXP Semiconductors product can reasonably be expected to result in personal injury, death or severe property or environmental damage. NXP Semiconductors accepts no liability for inclusion and/or use of NXP Semiconductors products in such equipment or applications and therefore such inclusion and/or use is at the customer's own risk.

**Applications** — Applications that are described herein for any of these products are for illustrative purposes only. NXP Semiconductors makes no representation or warranty that such applications will be suitable for the specified use without further testing or modification.

Customers are responsible for the design and operation of their applications and products using NXP Semiconductors products, and NXP Semiconductors accepts no liability for any assistance with applications or customer product design. It is customer's sole responsibility to determine whether the NXP Semiconductors product is suitable and fit for the customer's applications and products planned, as well as for the planned application and use of customer's third party customer(s). Customers should provide appropriate design and operating safeguards to minimize the risks associated with their applications and products.

NXP Semiconductors does not accept any liability related to any default, damage, costs or problem which is based on any weakness or default in the customer's applications or products, or the application or use by customer's third party customer(s). Customer is responsible for doing all necessary testing for the customer's applications and products using NXP Semiconductors products in order to avoid a default of the applications and the products or of the application or use by customer's third party customer(s). NXP does not accept any liability in this respect.

**Limiting values** — Stress above one or more limiting values (as defined in the Absolute Maximum Ratings System of IEC 60134) will cause permanent damage to the device. Limiting values are stress ratings only and (proper) operation of the device at these or any other conditions above those given in the Recommended operating conditions section (if present) or the Characteristics sections of this document is not warranted. Constant or repeated exposure to limiting values will permanently and irreversibly affect the quality and reliability of the device.

**Terms and conditions of commercial sale** — NXP Semiconductors products are sold subject to the general terms and conditions of commercial sale, as published at <http://www.nxp.com/profile/terms>, unless otherwise agreed in a valid written individual agreement. In case an individual agreement is concluded only the terms and conditions of the respective agreement shall apply. NXP Semiconductors hereby expressly objects to applying the customer's general terms and conditions with regard to the purchase of NXP Semiconductors products by customer.

**No offer to sell or license** — Nothing in this document may be interpreted or construed as an offer to sell products that is open for acceptance or the grant, conveyance or implication of any license under any copyrights, patents or other industrial or intellectual property rights.

**Export control** — This document as well as the item(s) described herein may be subject to export control regulations. Export might require a prior authorization from national authorities.

**Non-automotive qualified products** — Unless this data sheet expressly states that this specific NXP Semiconductors product is automotive qualified, the product is not suitable for automotive use. It is neither qualified nor tested in accordance with automotive testing or application requirements. NXP Semiconductors accepts no liability for inclusion and/or use of non-automotive qualified products in automotive equipment or applications.

In the event that customer uses the product for design-in and use in automotive applications to automotive specifications and standards, customer (a) shall use the product without NXP Semiconductors' warranty of the product for such automotive applications, use and specifications, and (b) whenever customer uses the product for automotive applications beyond

NXP Semiconductors' specifications such use shall be solely at customer's own risk, and (c) customer fully indemnifies NXP Semiconductors for any liability, damages or failed product claims resulting from customer design and use of the product for automotive applications beyond NXP Semiconductors' standard warranty and NXP Semiconductors' product specifications.

## 10.4 Trademarks

Notice: All referenced brands, product names, service names and trademarks are the property of their respective owners.

## 11. Contact information

For more information, please visit: <http://www.nxp.com>

For sales office addresses, please send an email to: [salesaddresses@nxp.com](mailto:salesaddresses@nxp.com)

## 12. Contents

<b>1</b>	<b>Product profile</b> . . . . .	<b>1</b>
1.1	General description . . . . .	1
1.2	Features and benefits . . . . .	1
1.3	Applications . . . . .	2
<b>2</b>	<b>Pinning information</b> . . . . .	<b>2</b>
<b>3</b>	<b>Ordering information</b> . . . . .	<b>2</b>
<b>4</b>	<b>Marking</b> . . . . .	<b>2</b>
<b>5</b>	<b>Limiting values</b> . . . . .	<b>3</b>
<b>6</b>	<b>Characteristics</b> . . . . .	<b>4</b>
<b>7</b>	<b>Application information</b> . . . . .	<b>5</b>
7.1	Insertion loss . . . . .	5
7.2	Crosstalk . . . . .	6
7.3	USIM interface application schematic . . . . .	7
<b>8</b>	<b>Package outline</b> . . . . .	<b>8</b>
<b>9</b>	<b>Revision history</b> . . . . .	<b>9</b>
<b>10</b>	<b>Legal information</b> . . . . .	<b>10</b>
10.1	Data sheet status . . . . .	10
10.2	Definitions . . . . .	10
10.3	Disclaimers . . . . .	10
10.4	Trademarks . . . . .	11
<b>11</b>	<b>Contact information</b> . . . . .	<b>11</b>
<b>12</b>	<b>Contents</b> . . . . .	<b>12</b>

Please be aware that important notices concerning this document and the product(s) described herein, have been included in section 'Legal information'.

© NXP B.V. 2010. All rights reserved.

For more information, please visit: <http://www.nxp.com>  
 For sales office addresses, please send an email to: [salesaddresses@nxp.com](mailto:salesaddresses@nxp.com)

Date of release: 22 July 2010  
 Document identifier: IP4264CZ8-20\_IP4264CZ8-40